

# Double Universal Joint

Needle roller bearings

Universal joints

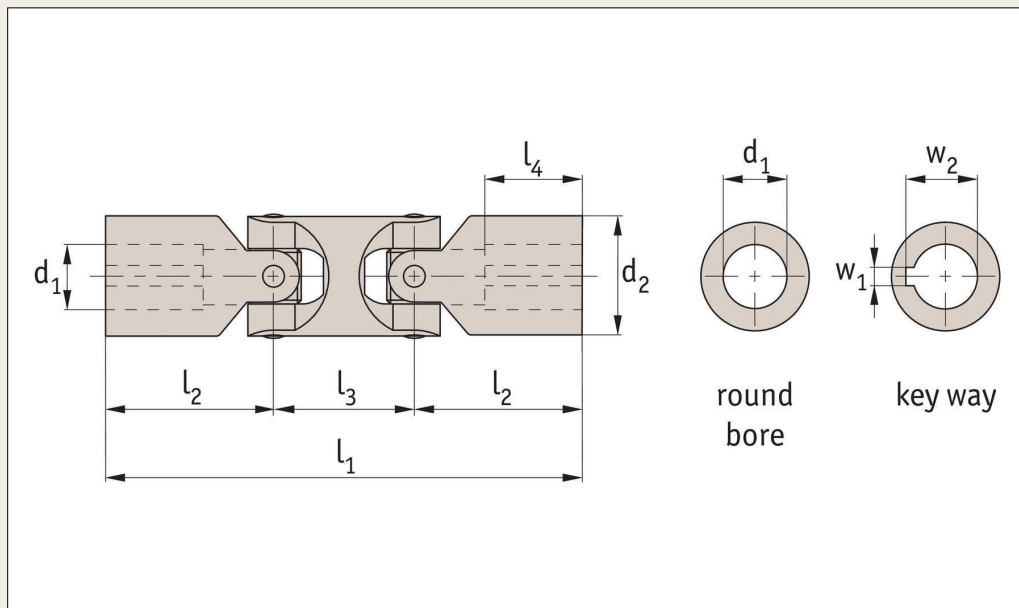

**R3686**

### Material

Steel (9SMnPb28k, no. 10718).  
Bearing type: needle roller bearing.

### Technical notes

To DIN 808.  
Maximum bending angle 45° per

joint.

Max. drive speed of 4000 rpm.  
Keyways aligned.

### Tips

Double universal joints are used  
where large bending angles are

required or where two shafts offset in  
relation to each other.

Product variations available on  
request, for square bores change the  
suffix to SQ for square bores or HX  
for hex bores.

Order No.	Bore	$d_{1\ H7}$	$d_2$	$l_1$	$l_2$	$l_3$	$l_4$	$w_{1\ JS9}$	$w_2$	$\frac{\Delta}{g}$
<b>R3686.010-RB</b>	Round bore	10	22	74	24,0	26	12	-	-	150
<b>R3686.012-RB</b>	Round Bore	12	25	86	28,0	30	13	-	-	250
<b>R3686.014-RB</b>	Round Bore	14	28	96	30,0	36	14	-	-	400
<b>R3686.016-RB</b>	Round Bore	16	32	104	34,0	36	16	-	-	450
<b>R3686.018-RB</b>	Round Bore	18	36	114	37,0	40	17	-	-	700
<b>R3686.020-RB</b>	Round Bore	20	42	128	41,0	46	18	-	-	1000
<b>R3686.022-RB</b>	Round Bore	22	45	145	47,5	50	22	-	-	1550
<b>R3686.025-RB</b>	Round Bore	25	50	163	54,0	55	26	-	-	2000
<b>R3686.030-RB</b>	Round Bore	30	58	190	61,0	68	29	-	-	2900
<b>R3686.032-RB</b>	Round Bore	32	58	198	65,0	68	33	-	-	3000
<b>R3686.035-RB</b>	Round Bore	35	70	212	70,0	72	35	-	-	4750
<b>R3686.040-RB</b>	Round Bore	40	80	245	80,0	85	39	-	-	7200
<b>R3686.050-RB</b>	Round Bore	50	95	290	95,0	100	46	-	-	12,000
<b>R3686.010-KW</b>	With keyway	10	22	74	24,0	26	12	3	11,4	150
<b>R3686.012-KW</b>	With Keyway	12	25	86	28,0	30	13	4	13,8	250
<b>R3686.014-KW</b>	With Keyway	14	28	96	30,0	36	14	5	16,3	400
<b>R3686.016-KW</b>	With Keyway	16	32	104	34,0	36	16	5	18,3	450
<b>R3686.018-KW</b>	With Keyway	18	36	114	37,0	40	17	6	20,8	700
<b>R3686.020-KW</b>	With Keyway	20	42	128	41,0	46	18	6	22,8	1000
<b>R3686.022-KW</b>	With Keyway	22	45	145	47,5	50	22	6	24,8	1550
<b>R3686.025-KW</b>	With Keyway	25	50	163	54,0	55	26	8	28,3	2000
<b>R3686.030-KW</b>	With Keyway	30	58	190	61,0	68	29	8	33,3	2900
<b>R3686.032-KW</b>	With Keyway	32	58	198	65,0	68	33	10	35,3	3000
<b>R3686.035-KW</b>	With Keyway	35	70	212	70,0	72	35	10	38,3	4750
<b>R3686.040-KW</b>	With Keyway	40	80	245	80,0	85	39	12	43,3	7200
<b>R3686.050-KW</b>	With Keyway	50	95	290	95,0	100	46	14	53,8	12,000

# SPRINGFIX® LINKAGES

...our linkages, your solution

## Universal Joints



When one single joint is coupled with two shafts (of which the driving one is rotating at a constant speed) forming an angle, a periodic variation of the driven shaft is caused with exactly four fluctuations per revolution.

The difference between the maximum and the minimum speed of the driven shaft depends on the angle formed by the two shafts. The difference grows with the increase of the angle  $\alpha^\circ$ . To have a smooth transmission, either two opposite single joints (ensuring that the two central yokes lie on the same plane and the angles are equal) or a double joint need to be fitted. The irregularity caused by the articulation of the first unisex joint is cancelled by the second unisex joint. The overall length resulting from the coupling of the two single joints can be reduced by using a double unisex joint. In other words, the double joint is to be considered as the shortest method of achieving smooth transmission.

For low speed applications (max. 1000 rpm), joints with plain bearings are recommended. They are able to support shock loads, motion reversal, irregular running and relatively high torques. The working angles must be restricted when using at speeds between 500 - 1000 rpm. Please consult our technical department if you have such an application.

For high rotation speeds, relatively low torques or wide angles, joints with needle roller bearings are preferred. They can reach 4000 rpm dependent on the angle.

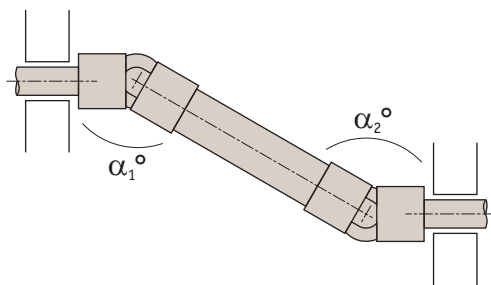

To obtain a uniform rotary motion always use either two opposite single joints or one double joint.  $\alpha_1 = \alpha_2$

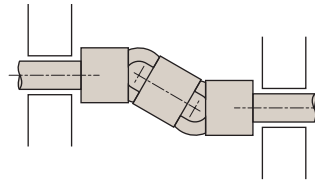

The pillow blocks supports should be positioned as close as possible to the joints

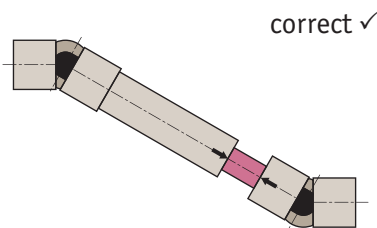

When using two opposite single joints ensure the alignment of the inside yokes

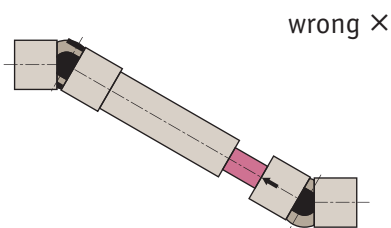

In extendable transmissions make sure that the arrows are perfectly aligned

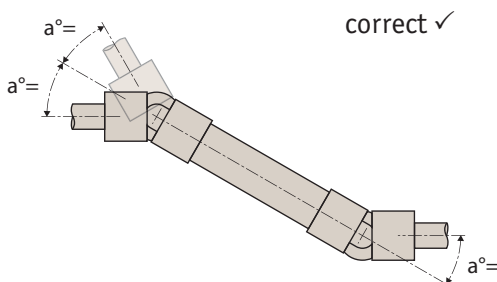

It is essential that the two bending angles  $a^\circ$  are equal

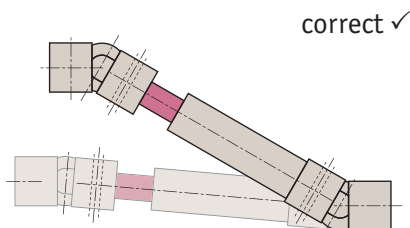

**How to read diagrams**

The joints capacity to transmit a regular torque at a constant load with no shocks, for a long period, mainly depends on the number of revolutions per minute and the inclination angle  $a^\circ$  of the two axes. The diagrams on the following pages are based on this. Each curve corresponds to the joint size (outside diameter "D") and represents the torque that the joint can transmit depending on speed and working angle  $a^\circ$ .

The diagrams can be directly read if angle ( $a^\circ$ ) is  $10^\circ$ . For wider angles, torques are reduced, these should be corrected using the correction vales (F) relating to the angle shown in the table.

**IMPORTANT**

Graph values are merely indicative and refer to the single joints only. When choosing a double joint, you have to consider that they can transmit a torque about 10% lower than the same sized single joints. Each application has its own particular motion characteristics, such as: shock loads, motion reversals, connected masses, kind of starting, presence of elastic joints, stops and starts, etc., that have to be considered when choosing the joint.

Working angle $a^\circ$	Correction value F
5°	1,25
10°	1,00
15°	0,80
20°	0,65
25°	0,55
30°	0,45
35°	0,38
40°	0,30
45°	0,25

**Torque Calculation for Plain Bearings**

Power: 0,65 KW, RPM: 230

With working angle a  $10^\circ$  Value F = 1 we get point P. Torque = 27 Nm corresponding to joint size "D" = 25/26mm. = Types R3688.016 and R3689.012

With working angle a  $30^\circ$  Value F = 0.45 (Kw 0,65: 0,45 = 1,44Kw) we get point P1 Torque = 60 Nm corresponding to joint size "D" = 32mm. = Types R3688.020 and R3689.016

Consider that:

$$\text{Torque in Nm} = 9550 \times \frac{\text{Power (KW)}}{\text{RPM}}$$

$$\text{Torque in Nm} = 7020 \times \frac{\text{Power (HP)}}{\text{RPM}}$$

Note: 1 KW = 1,35 HP and HP = 0,736 KW

Note: 1 Kgm = 9,81 Nm and Nm = 0,102 Kgm

## Torque Ratings for Plain Bearing Universal Joints

### Plain Bearings Single & Double Universal Joints

Not applicable for stainless versions, please contact our Technical Sales Department for further details.

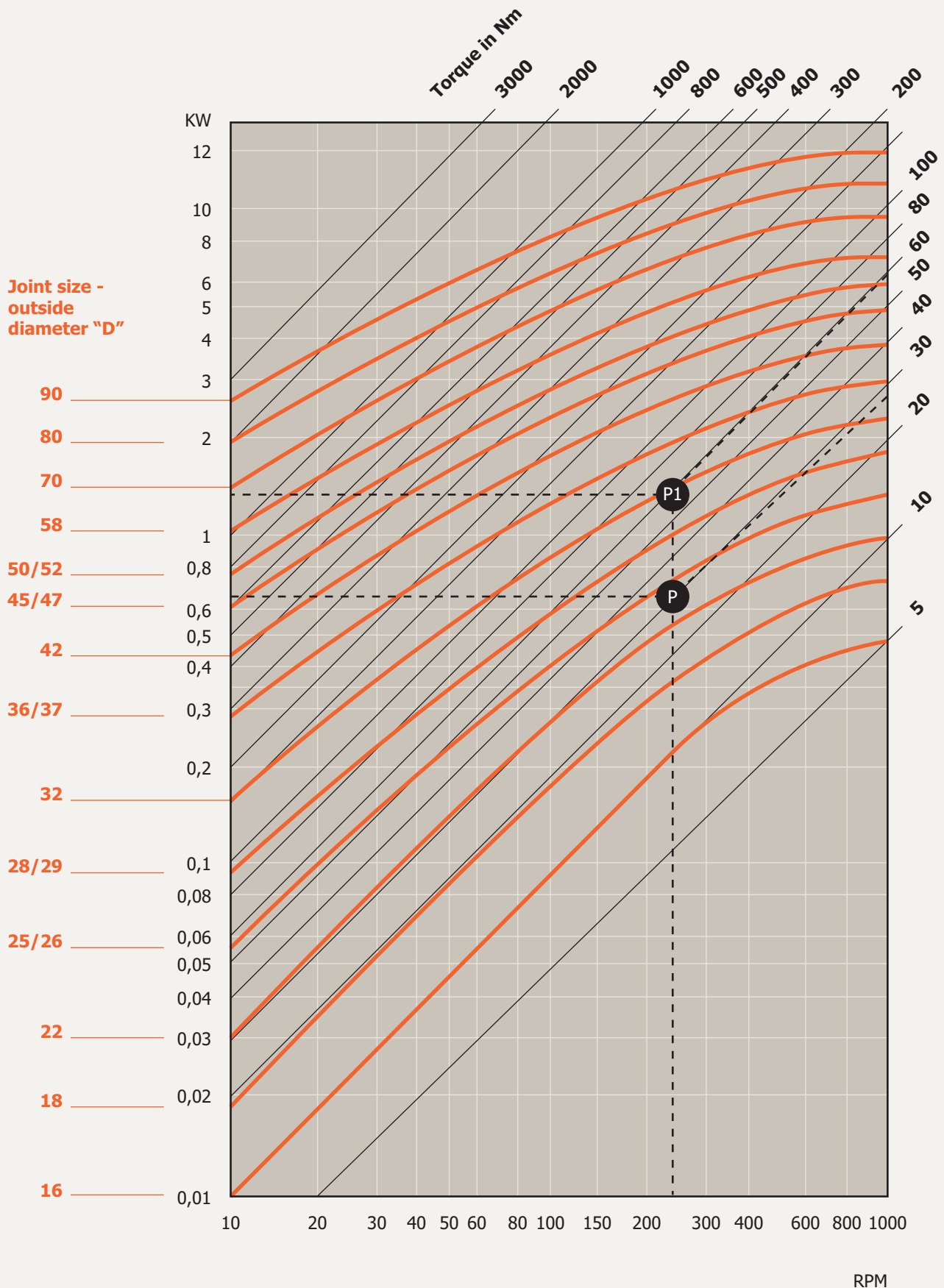

\*For double universal joints reduce torque by 15%

01483 266 784

Working angle a°	Correction value F
5°	1,25
10°	1,00
15°	0,90
20°	0,80
25°	0,70
30°	0,50
35°	0,40
40°	0,30
45°	0,25

**Torque Calculation**

Power: 0,55 KW, RPM: 2300

With working angle a 10° Value F = 1 we get point P. Torque = 23 Nm corresponding to joint size "D" = 28mm. = Type R3686.014

With working angle a 25° Value F = 0.70 (Kw 5,5: 0,70 = 7,85Kw) we get point P1 Torque = 33 Nm corresponding to joint size "D" = 32mm. = Type R3686.016

Consider that:

$$\text{Torque in Nm} = 9550 \times \frac{\text{Power (KW)}}{\text{RPM}}$$

$$\text{Torque in Nm} = 7020 \times \frac{\text{Power (HP)}}{\text{RPM}}$$

Note: 1 KW = 1,35 HP and HP = 0,736 KW

Note: 1 Kgm = 9,81 Nm and 1Nm = 0,102 Kgm

**Factor in a safety factor for shock load, reciprocating methods, start-up shocks etc.**

## Torque Ratings for Needle Roller Bearings Universal Joints

### Needle Roller Bearings Single & Double Universal Joints

Not applicable for stainless versions, please contact our Technical Sales Department for further details.

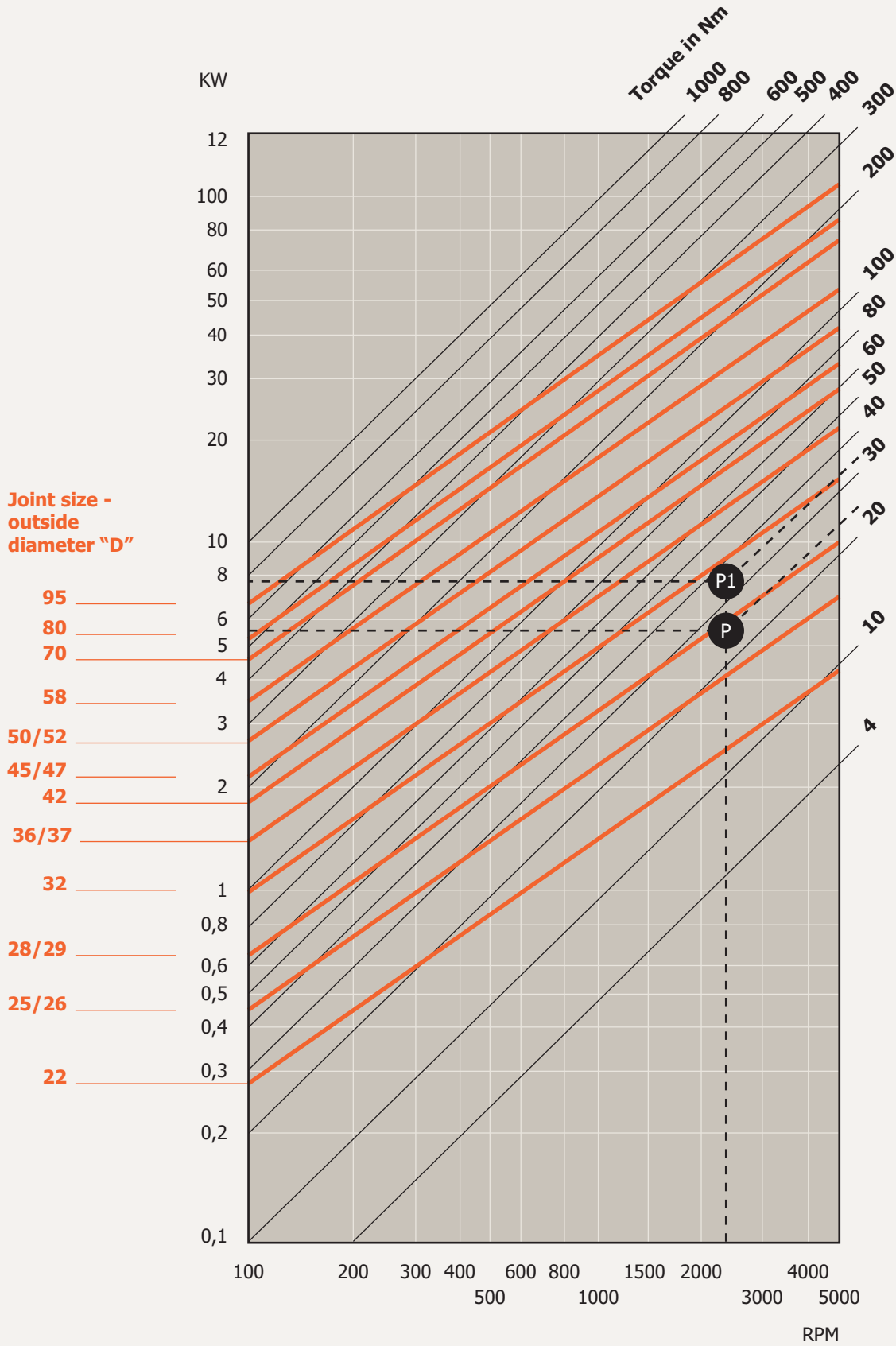

**\*For double universal joints reduce torque by 15%**