

Stainless Double Universal Joint

Stainless unbored - solid ends

Universal joints

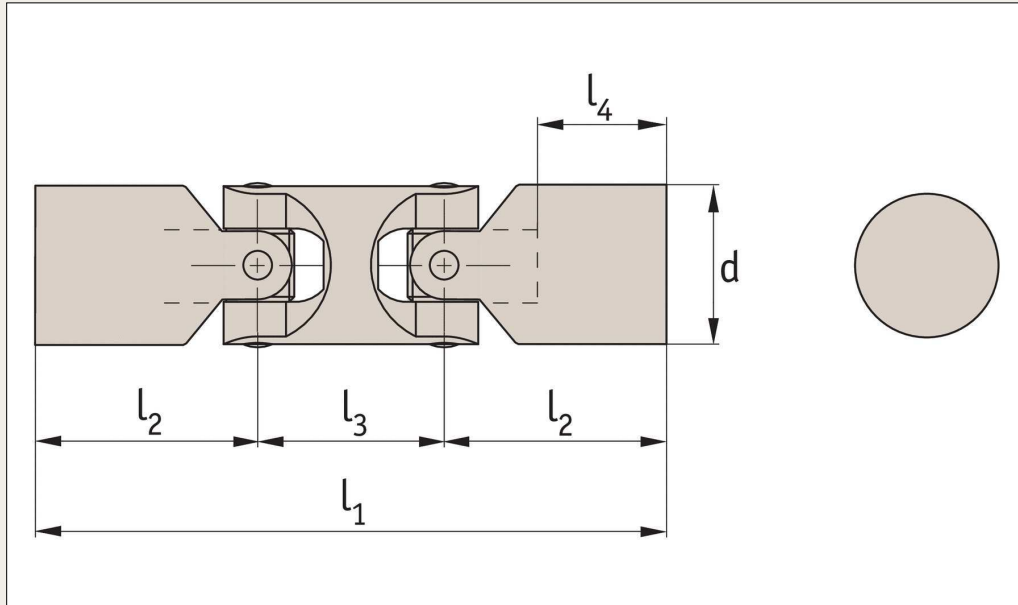

R3697

Material

Stainless steel (AISI 304), bearing type: Plain bearing.

To DIN 808.

Maximum bending angle 45° per joint.

Max. drive speed of joints with journal bearings 1000 rpm.

Double universal joints are used where large bending angles are required or where two shafts offset in relation to each other.

Product variations available on request: square bores and hex bores.

Technical notes

Tips

Order No.	Bore	d h4	l ₁	l ₂	l ₃	l ₄	Δ [±] g
R3697.013	Unbored	13	61	21	18	14	50
R3697.017	Unbored	17	63	20	22	12	80
R3697.018	Unbored	17	75	26	22	18	80
R3697.020	Unbored	20	89	31	26	21	150
R3697.025	Unbored	25	87	28	30	16	250
R3697.026	Unbored	25	105	37	30	25	350
R3697.032	Unbored	32	125	43	38	26	450
R3697.040	Unbored	40	155	54	46	34	1000
R3697.050	Unbored	50	189	66	56	42	2000
R3697.060	Unbored	60	237	83	70	53	3000

SPRINGFIX® LINKAGES

...our linkages, your solution

Universal Joints



When one single joint is coupled with two shafts (of which the driving one is rotating at a constant speed) forming an angle, a periodic variation of the driven shaft is caused with exactly four fluctuations per revolution.

The difference between the maximum and the minimum speed of the driven shaft depends on the angle formed by the two shafts. The difference grows with the increase of the angle α° . To have a smooth transmission, either two opposite single joints (ensuring that the two central yokes lie on the same plane and the angles are equal) or a double joint need to be fitted. The irregularity caused by the articulation of the first unisex joint is cancelled by the second unisex joint. The overall length resulting from the coupling of the two single joints can be reduced by using a double unisex joint. In other words, the double joint is to be considered as the shortest method of achieving smooth transmission.

For low speed applications (max. 1000 rpm), joints with plain bearings are recommended. They are able to support shock loads, motion reversal, irregular running and relatively high torques. The working angles must be restricted when using at speeds between 500 - 1000 rpm. Please consult our technical department if you have such an application.

For high rotation speeds, relatively low torques or wide angles, joints with needle roller bearings are preferred. They can reach 4000 rpm dependent on the angle.

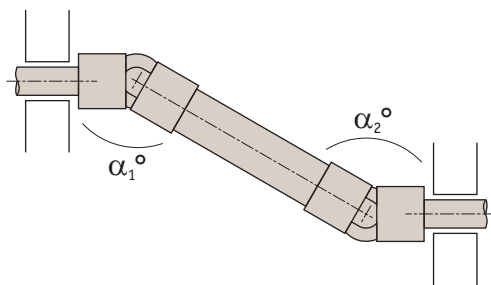

To obtain a uniform rotary motion always use either two opposite single joints or one double joint. $\alpha_1 = \alpha_2$

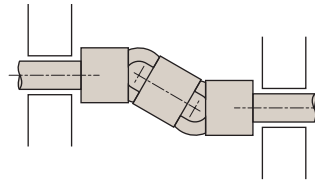

The pillow blocks supports should be positioned as close as possible to the joints

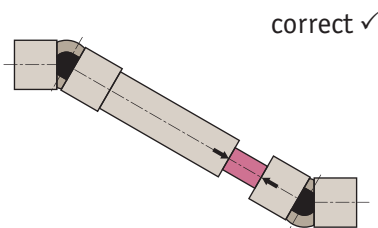

When using two opposite single joints ensure the alignment of the inside yokes

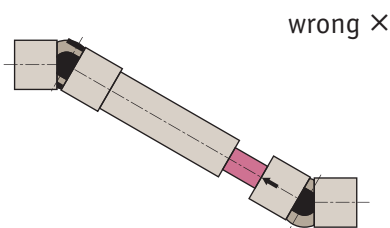

In extendable transmissions make sure that the arrows are perfectly aligned

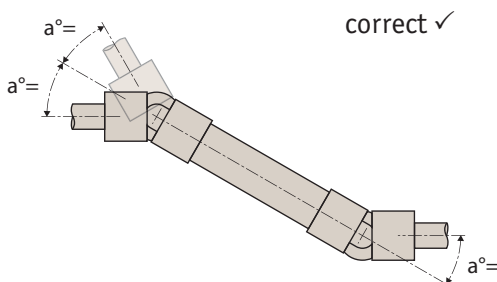

It is essential that the two bending angles a° are equal

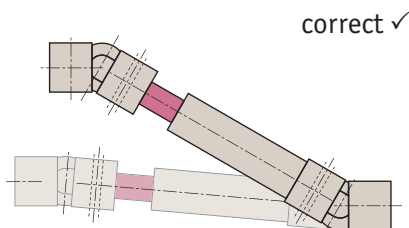

How to read diagrams

The joints capacity to transmit a regular torque at a constant load with no shocks, for a long period, mainly depends on the number of revolutions per minute and the inclination angle a° of the two axes. The diagrams on the following pages are based on this. Each curve corresponds to the joint size (outside diameter "D") and represents the torque that the joint can transmit depending on speed and working angle a° .

The diagrams can be directly read if angle (a°) is 10° . For wider angles, torques are reduced, these should be corrected using the correction vales (F) relating to the angle shown in the table.

IMPORTANT

Graph values are merely indicative and refer to the single joints only. When choosing a double joint, you have to consider that they can transmit a torque about 10% lower than the same sized single joints. Each application has its own particular motion characteristics, such as: shock loads, motion reversals, connected masses, kind of starting, presence of elastic joints, stops and starts, etc., that have to be considered when choosing the joint.

Working angle a°	Correction value F
5°	1,25
10°	1,00
15°	0,80
20°	0,65
25°	0,55
30°	0,45
35°	0,38
40°	0,30
45°	0,25

Torque Calculation for Plain Bearings

Power: 0,65 KW, RPM: 230

With working angle a 10° Value F = 1 we get point P. Torque = 27 Nm corresponding to joint size "D" = 25/26mm. = Types R3688.016 and R3689.012

With working angle a 30° Value F = 0.45 (Kw 0,65: 0,45 = 1,44Kw) we get point P1 Torque = 60 Nm corresponding to joint size "D" = 32mm. = Types R3688.020 and R3689.016

Consider that:

$$\text{Torque in Nm} = 9550 \times \frac{\text{Power (KW)}}{\text{RPM}}$$

$$\text{Torque in Nm} = 7020 \times \frac{\text{Power (HP)}}{\text{RPM}}$$

Note: 1 KW = 1,35 HP and HP = 0,736 KW

Note: 1 Kgm = 9,81 Nm and Nm = 0,102 Kgm

Plain Bearings Single & Double Universal Joints

Not applicable for stainless versions, please contact our Technical Sales Department for further details.

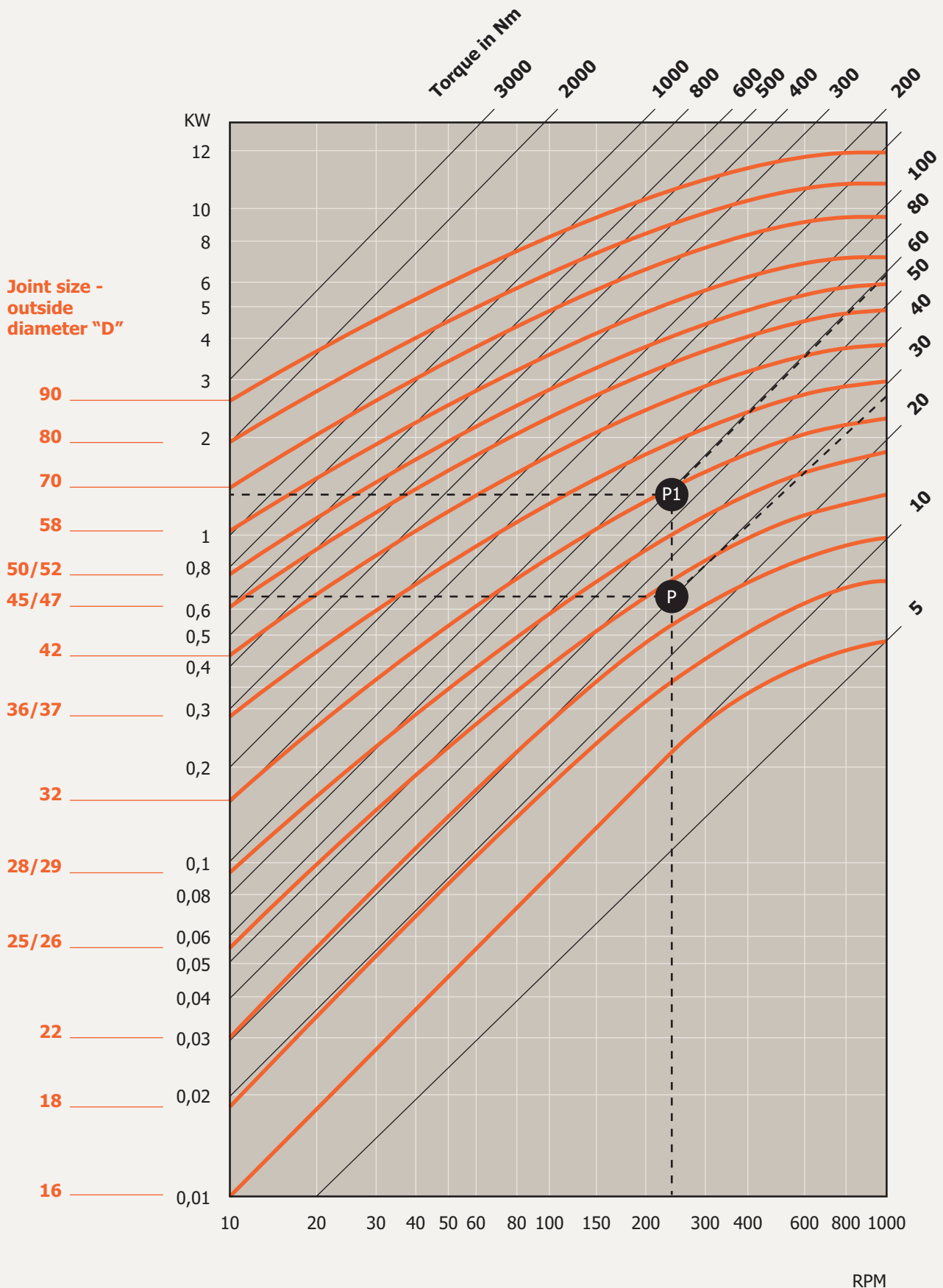

*For double universal joints reduce torque by 15%

RPM

01483 266 784

Working angle a°	Correction value F
5°	1,25
10°	1,00
15°	0,90
20°	0,80
25°	0,70
30°	0,50
35°	0,40
40°	0,30
45°	0,25

Torque Calculation

Power: 0,55 KW, RPM: 2300

With working angle a 10° Value F = 1 we get point P. Torque = 23 Nm corresponding to joint size "D" = 28mm. = Type R3686.014

With working angle a 25° Value F = 0.70 (Kw 5,5: 0,70 = 7,85Kw) we get point P1 Torque = 33 Nm corresponding to joint size "D" = 32mm. = Type R3686.016

Consider that:

$$\text{Torque in Nm} = 9550 \times \frac{\text{Power (KW)}}{\text{RPM}}$$

$$\text{Torque in Nm} = 7020 \times \frac{\text{Power (HP)}}{\text{RPM}}$$

Note: 1 KW = 1,35 HP and HP = 0,736 KW

Note: 1 Kgm = 9,81 Nm and 1Nm = 0,102 Kgm

Factor in a safety factor for shock load, reciprocating methods, start-up shocks etc.

Torque Ratings for Needle Roller Bearings Universal Joints

Needle Roller Bearings Single & Double Universal Joints

Not applicable for stainless versions, please contact our Technical Sales Department for further details.

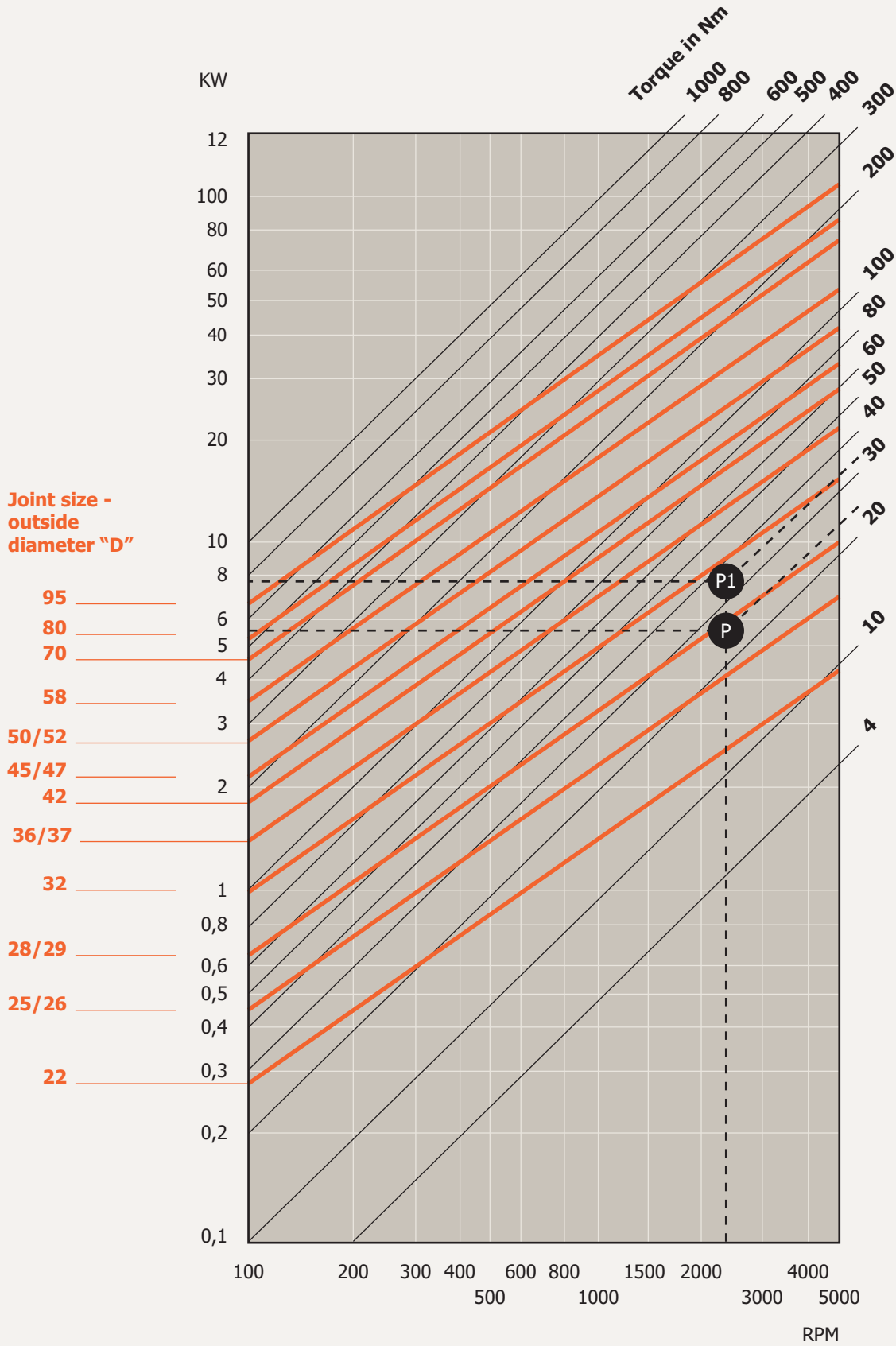

*For double universal joints reduce torque by 15%